

亲爱的用户：非常感谢您选用本公司产品！

1. 产品简介

Cyber-BT是一款实现我公司太阳能控制器具有蓝牙通讯功能的串口适配器，配合手机APP即可对系统进行无线监控及参数设置等操作。

主要特点：

- 实现太阳能控制器的无线监控功能
- 支持手机APP，即插即用，设置简单方便
- 使用高性能，超低功耗的蓝牙专用芯片
- 采用蓝牙4.0和BLE技术，具有快速通讯、抗干扰能力强等特点
- 无需外接电源
- 通讯距离最高可达10米
- Reset一键复位适配器

2. 结构

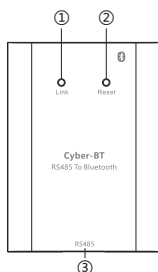

- ①指示灯：通讯连接指示灯
 ②复位键：一键复位蓝牙适配器
 ③RS485接口：用于连接太阳能控制器

3. 尺寸

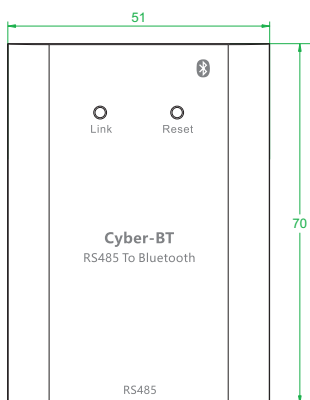

4. 指示灯

蓝色 LED	闪烁 (2/4s)	通信故障
	闪烁 (0.1/0.1)	连接成功
	闪烁 (0.2/5s)	正常工作
	常亮	复位成功

5. 连接图

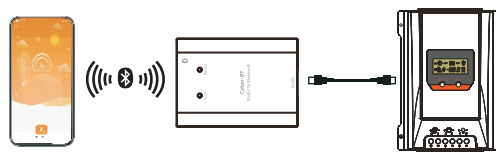

注：连接线需使用专用连接线！

RJ11接口定义如下：

引脚编号	定义
1	NC
2	NC
3	RS485-A
4	RS485-B
5	NC
6	NC

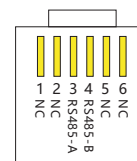

RJ11接口

6. 操作说明

详细操作方式请参考SolarLife手机APP使用手册！

7. 技术参数

型号	Cyber-BT
输入电压	5Vdc (通讯串口直接供电)
待机功耗	0.08W
运行功耗	0.09W
通讯距离	≤10米
串口波特率	9600bps
频率范围	2400-2483.5MHz
通讯方式	RS485转BLE
接口类型	RJ11
尺寸	70*51*24.5mm
重量	50克
工作温度	-20~70°C
防护等级	IP30

如有更改，恕不另行通知！

Dear user, thank you for selecting our product!

1.Product Introduction

Cyber-BT is a kind of serial adpter which can make our company' s solar controller be with bluetooth communication function, and carry out wireless monitoring, parameter setting, and etc. for the system only by cooperating with mobile phone APP. Plug and play, simple and convenient set, it has many excellent features.

It comes with a number of outstanding features, such as:

- Realize wireless monitoring function of solar controller
- Support mobile phone APP, plug and play, simple and convenient to set
- Use high performance, ultra-low power consumption Bluetooth dedicated chip
- Adopt Bluetooth 4.0 and BLE technology
- Fast communication, strong anti-interference ability
- No need of external power supply
- Communication distance up to 10m
- Master reset adapter

2.Structure & Accessory

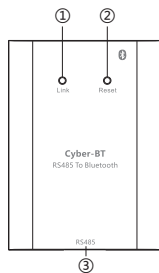

- ①Link Indicator: Communication connection indicator
- ②Reset Key: Master reset adapter
- ③RS485 Interface: Connect the controller with RS485

3.Dimension

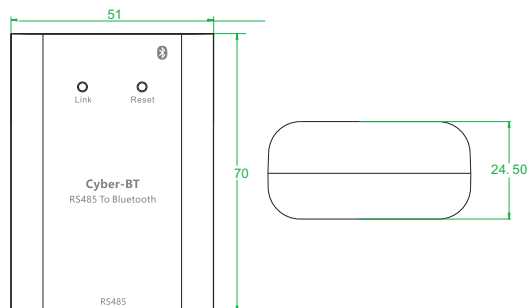

4.Indicator

Blue LED	Flash (2/4s)	Communication failure
	Flash (0.1/0.1s)	Connection succeeded
	Flash (0.2/5s)	Working normally
	On	Reset succeeded

5.System Connection Diagram

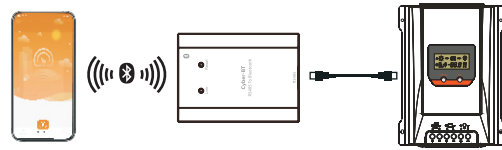

Note: Special cable is required!

Interface is defined as follows:

Pin No.	Definition
1	NC
2	NC
3	RS485-A
4	RS485-B
5	NC
6	NC

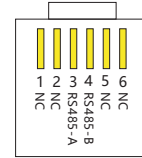

Interface

6.Operation Instruction

For details, please refer to user manual of mobile phone APP(SolarLife).

7.Parameters

Item	Cyber-BT
Input voltage	10~60Vdc
Standby power consumption	0.08W
Operation power consumption	0.09W
Communication distance	≤10m
Port baud rate	9600bps
RF output power	-6 ~ 4 dBm
Frequency range	2400-2483.5MHz
Modulation	GFSK
Antenna type and Gain	Integral antenna, 2db
Communication	RS485 to BLE
Interface type	RJ11
Dimension	70*51*24.5mm
Weight	50g
Woking temperature	-20~70°C
Protection degree	IP30

Any changes without prior notice!